

Cylinder series

GL13-3X28W

optical lens



Technical Parameters:

Name	Parameters
Light source:	COB
Input Voltage:	AC220~240V 50/60Hz
LED Current:	700mA, 35-37V
Beam Angle:	12°/24°/36°
Life Time:	> 50,000h - L80 - B10 (Ta 25° C)
Operating temperature:	-20°C~40°C
Certificate:	CE/RoHS
Weight:	1.8kg

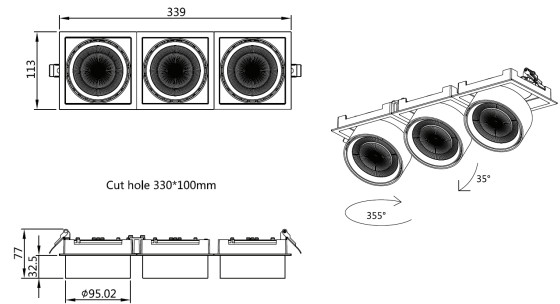

Ordering Information:

○ White ● Black

Power	CRI	Beam Angle	Luminous	CCT	Housing	Part Number
3x28W	>80	▲ 12°	3X2825 lm	3000K	○	GL1331-3X28W-830-W-12
					●	GL 1331-3X28W-830-B-12
		▲ 24°	3X2897 lm	4000K	○	GL1331-3X28W-840-W-12
					●	GL 1331-3X28W-840-B-12
		▲ 36°	3X2803 lm	3000K	○	GL 1331-3X28W-830-W-24
					●	GL1331-3X28W-830-B-24
	>90	▲ 12°	3X2871 lm	4000K	○	GL1331-3X28W-840-W-24
					●	GL1331-3X28W-840-B-24
		▲ 24°	3X2876 lm	3000K	○	GL1331-3X28W-830-W-36
					●	GL 1331-3X28W-830-B-36
		▲ 36°	3X2942 lm	4000K	○	GL1331-3X28W-840-W-36
					●	GL 1331-3X28W-840-B-36
>90	▲ 12°	3X2165 lm	3000K	○	GL 1331-3X28W-930-W-12	
				●	GL1331-3X28W-930-B-12	
	▲ 24°	3X2159 lm	3000K	○	GL1331-3X28W-930-W-24	
				●	GL1331-3X28W-930-B-24	
	▲ 36°	3X2217 lm	3000K	○	GL1331-3X28W-930-W-36	
				●	GL 1331-3X28W-930-B-36	

Technical Data test pattern:

CRI80 12°

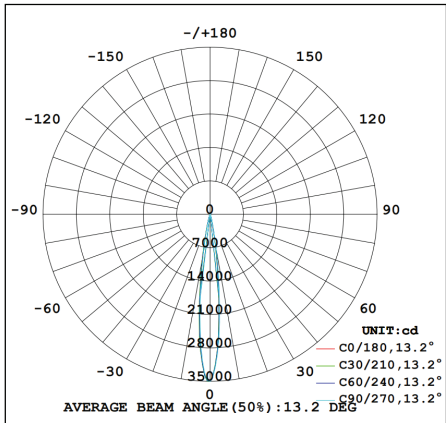

3000K

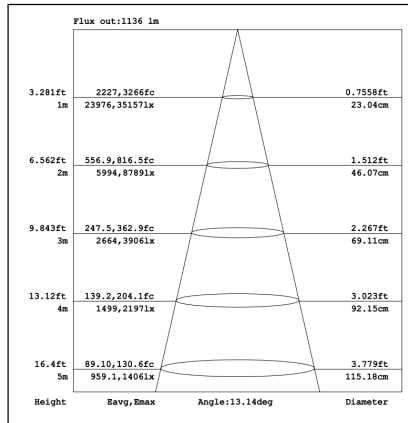

4000K

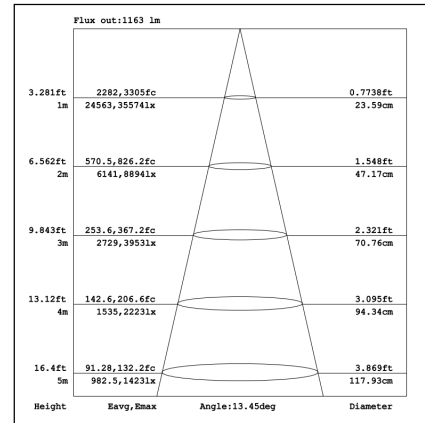

CRI80 24°

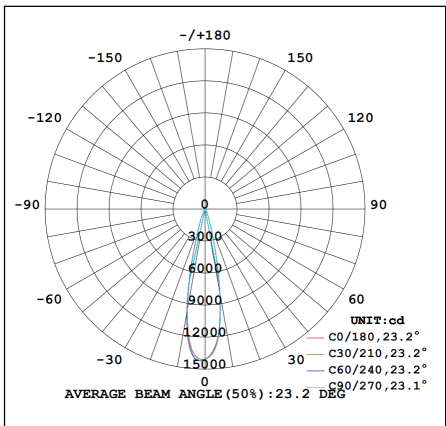

3000K

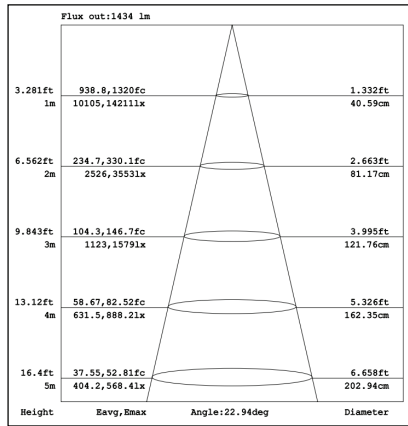

4000K

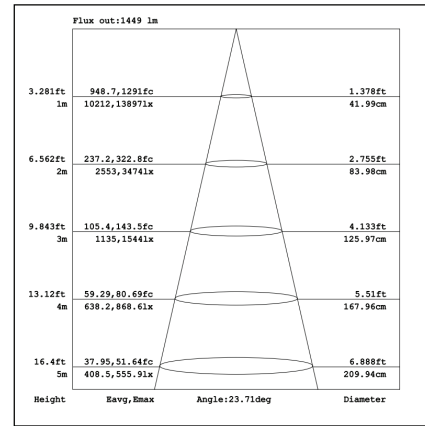

CRI80 36°

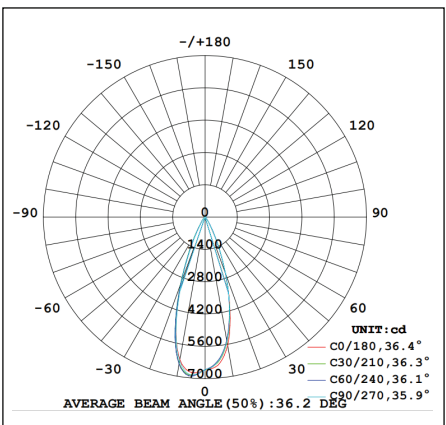

3000K

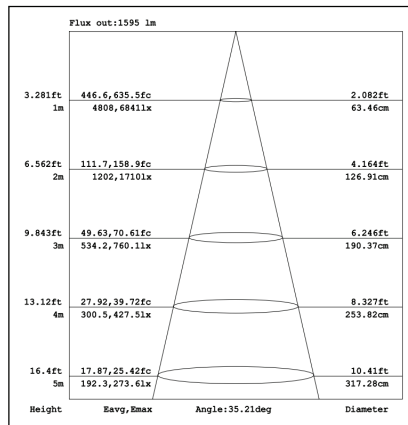

4000K

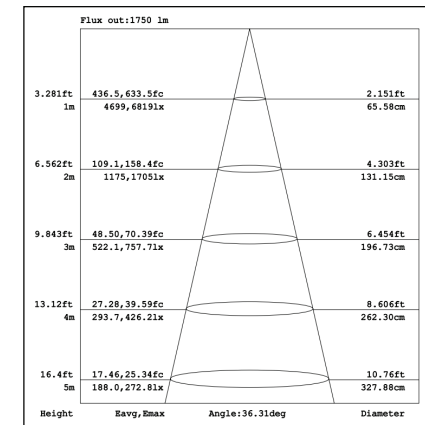

CRI90 12°

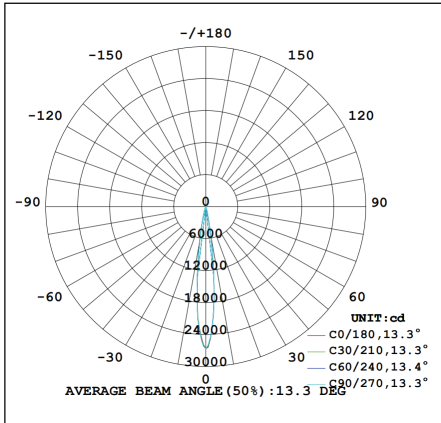

3000K

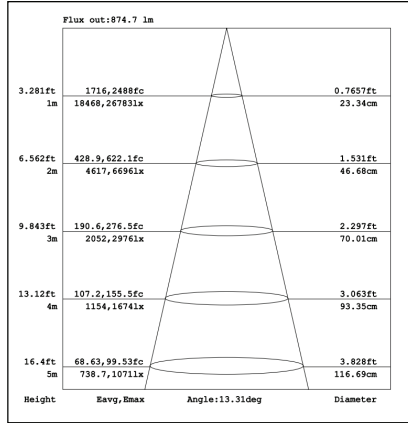

4000K

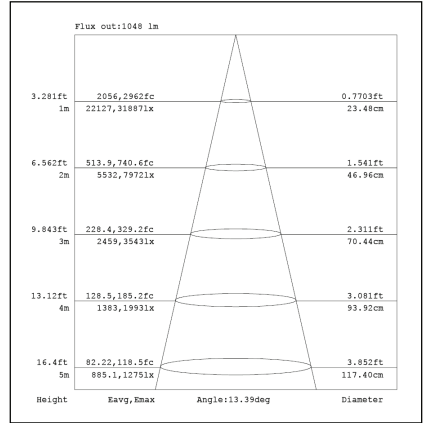

4000K

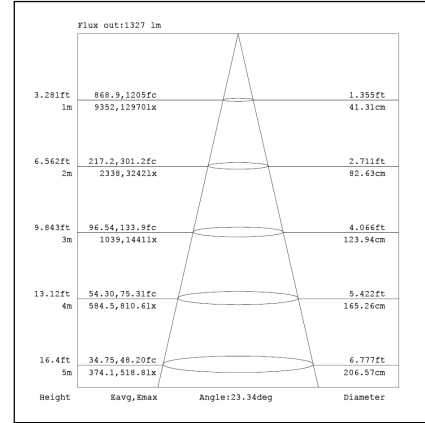

CRI90 24°

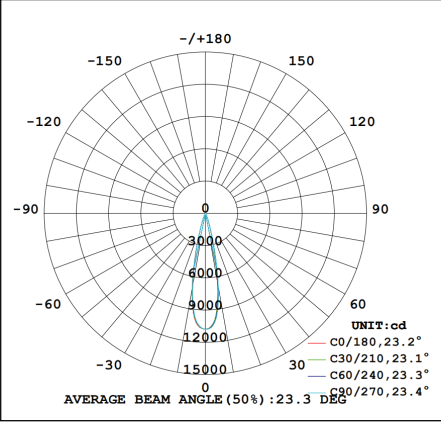

3000K

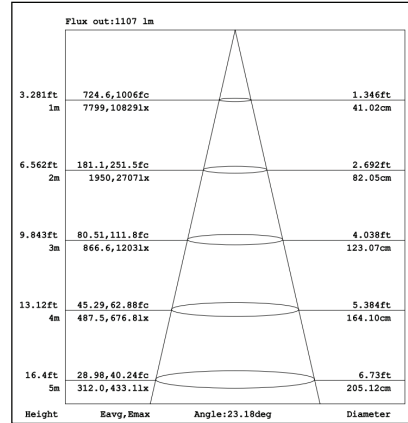

4000K

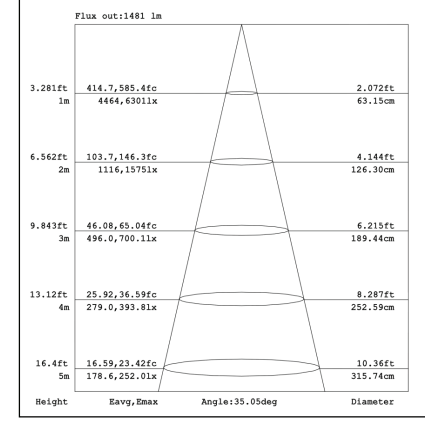

CRI90 36°

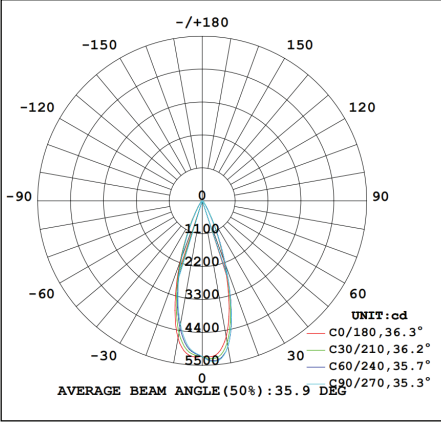

3000K

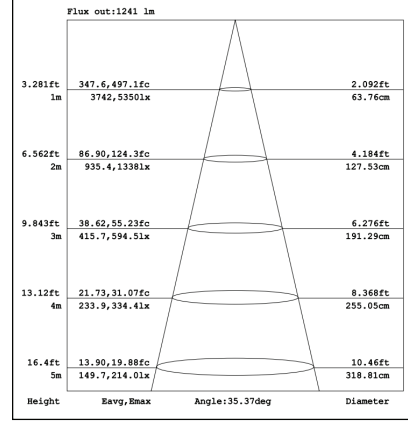

Packaging:

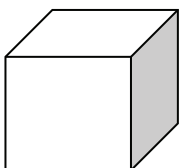

Box
 L450*W170*H90mm
 1pc/box
 GW: 1.85kg/box

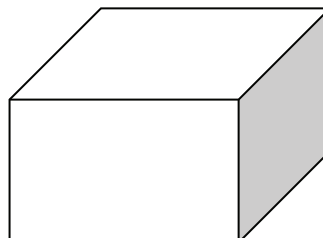

Outer carton
 L550*W465*H300mm
 9pcs/CTN
 GW: 17.5kg/carton

GL13 Installation Instruction

1, Cut Hole

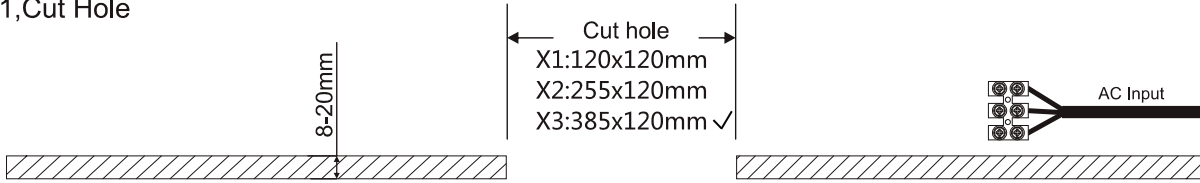

2, Connect Wire

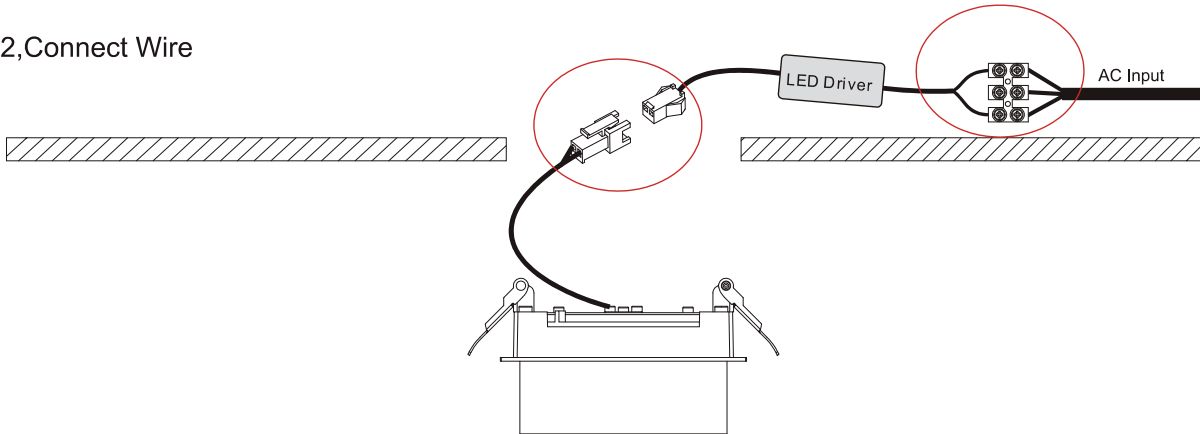

3, Fit the luminaire in the hole

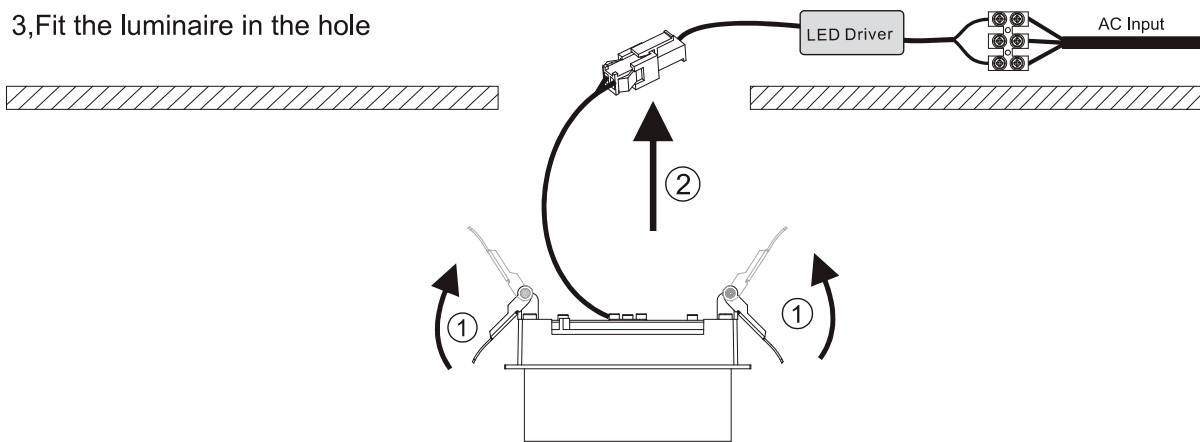

4, Finish

