

Pro Series

RL07-30W

Reflector



Technical Parameters:

Name	Parameters
Light source:	COB
Input Voltage:	AC220~240V 50/60Hz
LED Current:	700mA (35-37V)
Rated life:	>50,000 hours
Operating temperature:	-20°C~40°C
Storage temperature:	-30°C~60°C
Certificate:	CE ROHS
Weight:	1.45KG

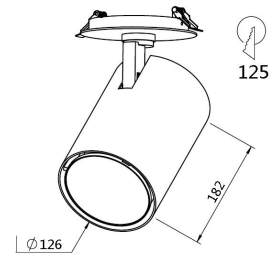

Ordering Information:

○ White ● Black

Power	CRI	Beam Angle	Luminous	CCT	Housing	Part Number
30W	>80	▲12°	2830 lm	3000K	○	RL071-30W-830-W-12
			3030 lm	4000K	○	RL071-30W-840-W-12
		▲20°	2860 lm	3000K	○	RL071-30W-830-W-20
			3050 lm	4000K	○	RL071-30W-840-W-20
		▲45°	2740 lm	3000K	○	RL071-30W-830-W-45
			2920 lm	4000K	○	RL071-30W-840-W-45
	>90	▲12°	2590 lm	3000K	○	RL071-30W-930-W-12
			2690 lm	4000K	○	RL071-30W-940-W-12
		▲20°	2600 lm	3000K	○	RL071-30W-930-W-20
			2720 lm	4000K	○	RL071-30W-940-W-20
		▲45°	2480 lm	3000K	○	RL071-30W-930-W-45
			2600 lm	4000K	○	RL071-30W-940-W-45



Technical Data test pattern

CRI80 12°

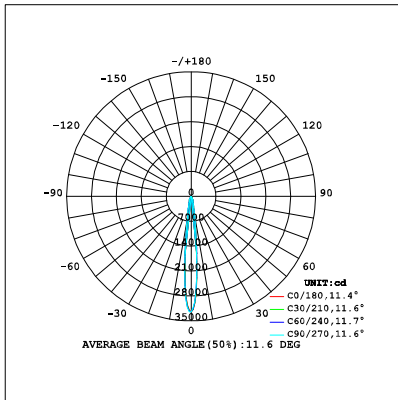

3000K

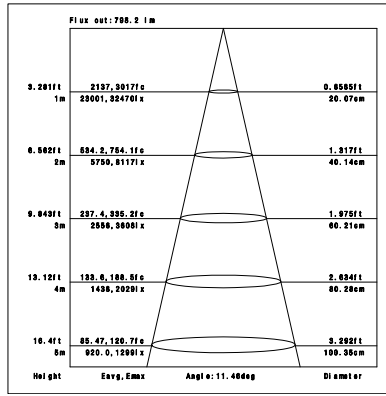

4000K

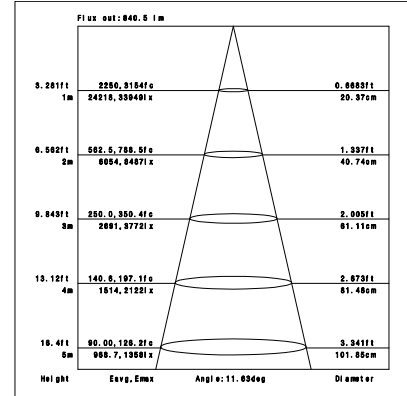

CRI80 20°

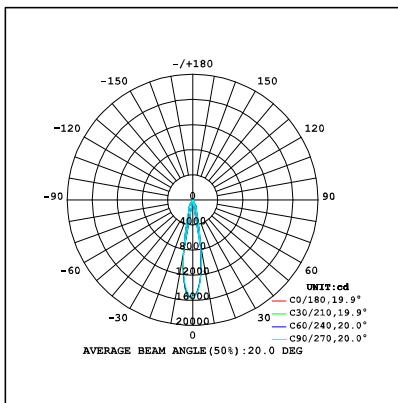

3000K

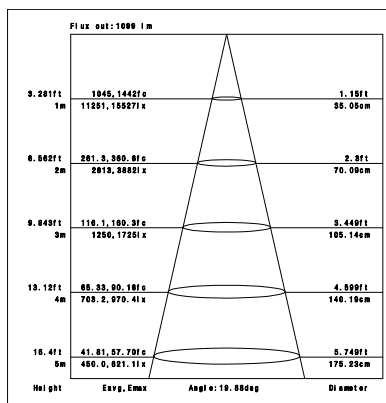

4000K

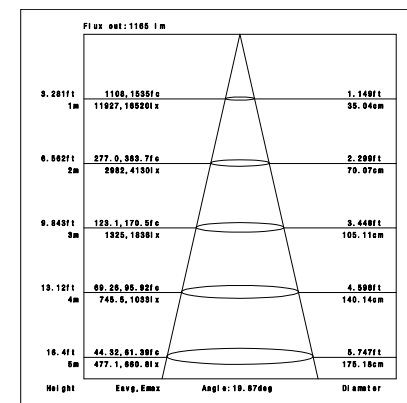

CRI80 45°

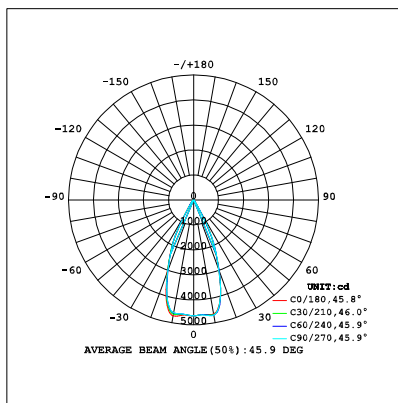

3000K

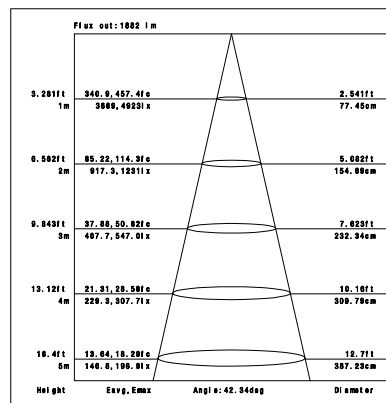

4000K

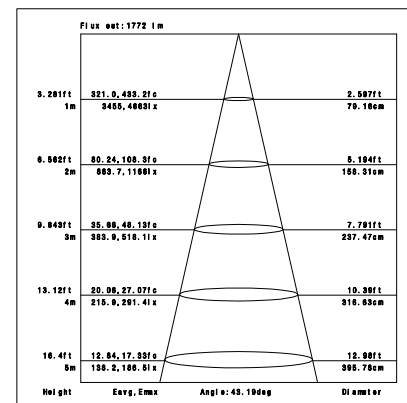

CRI90 12°

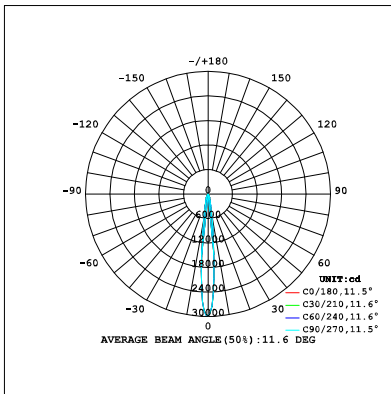

3000K

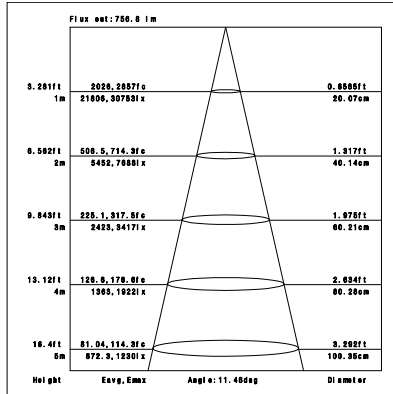

4000K

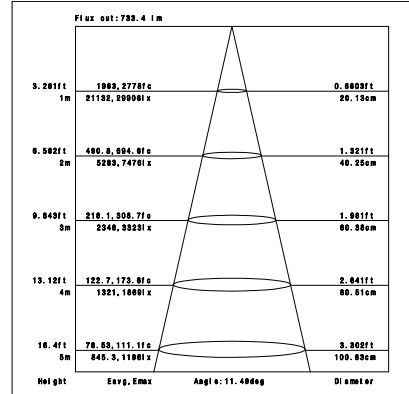

CRI90 20°

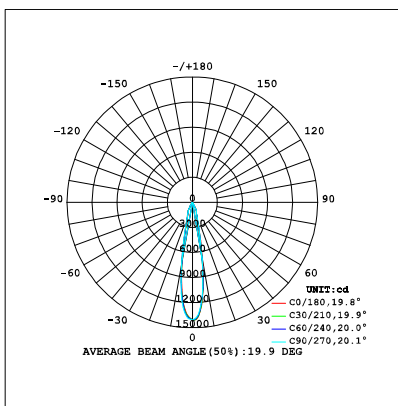

3000K

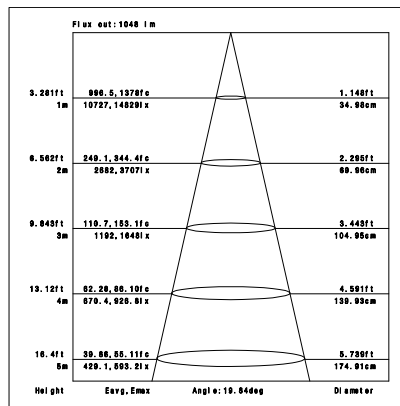

4000K

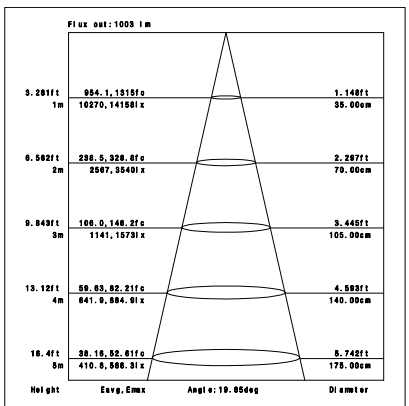

CRI90 45°

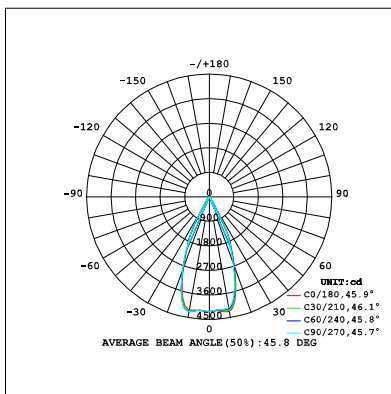

3000K

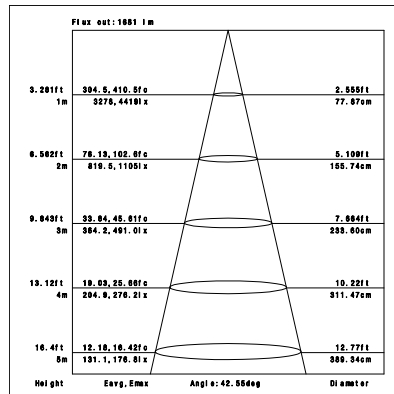

4000K

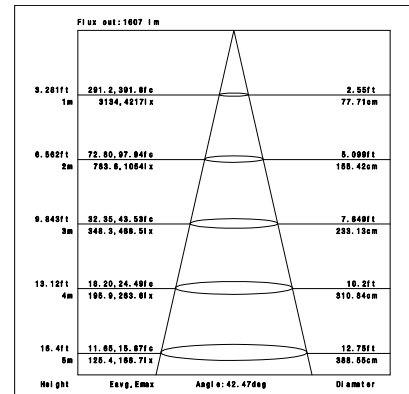

Packaging:

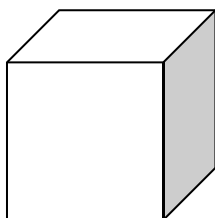

Box
L230*W140*H280mm
1pc/box
GW: 1.55kg/box

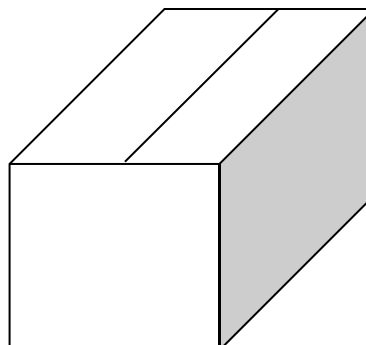

Outer carton
L730xW310xH350mm
6 pcs/CTN
GW: 10.5kg/carton

Installation instruction



1, Cut Hole

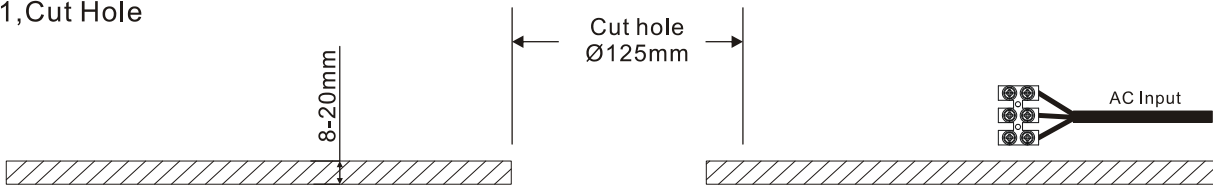

2, Connect Wire

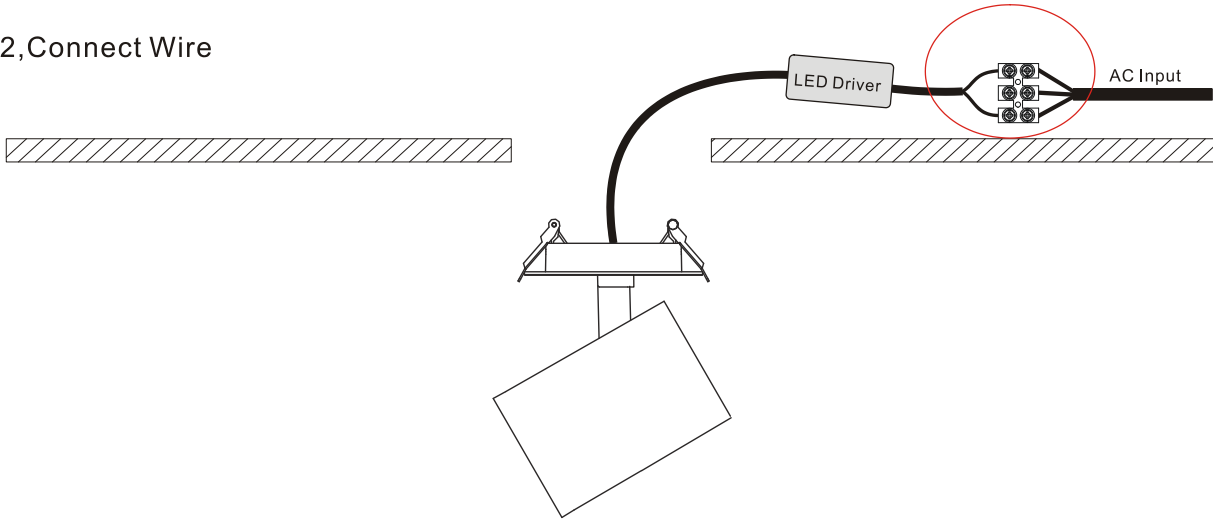

3, Fit the luminaire in the hole

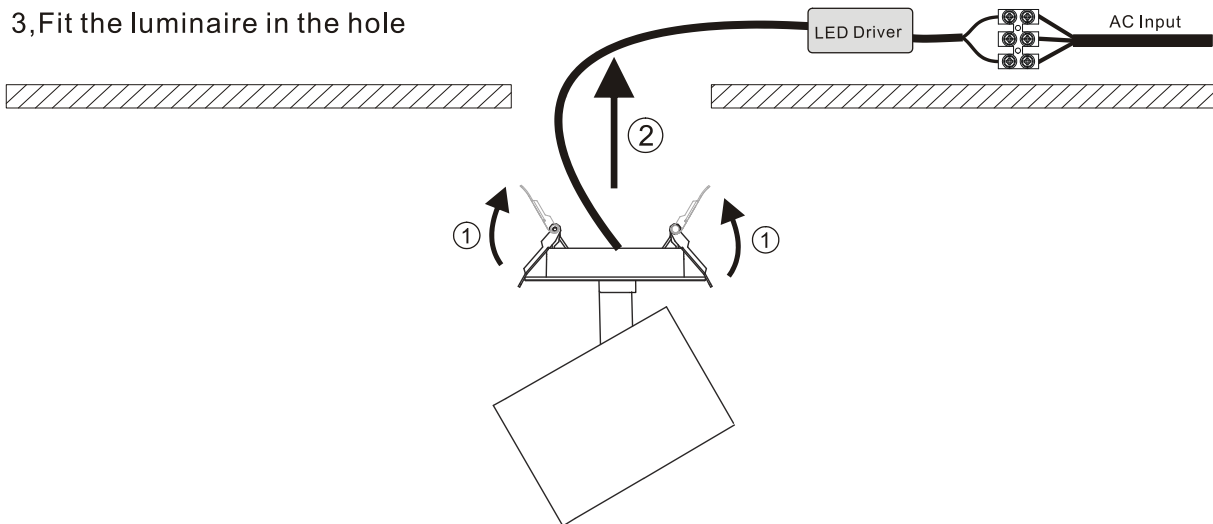

4, Finish

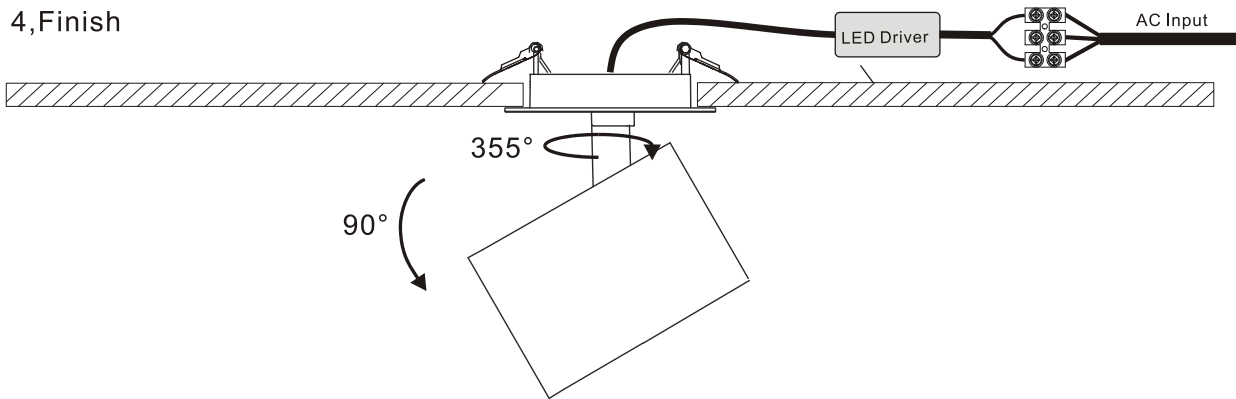

Product naming system

RL (X) XX X (H) - XW - X XX - X - XX



