

SD1-L328A/L646A /L964A

Technical Parameters:

Name	Parameters		
Light source:	3030SMD		
Input Voltage:	AC100~277V 50/60Hz		
Power	15W	30W	40W
LED Current:	350mA	700mA	1000mA
Rated life:	>50,000 hours		
Operating temperature:	-20°C~40°C		
Storage temperature:	-30°C~60°C		
Certificate:	CE/RoHS		
Dimmability:	Non-dimmable 0-10V dimming		
Weight:	0.8KG (L328) 1.4KG (L646) 2.0KG (L964)		

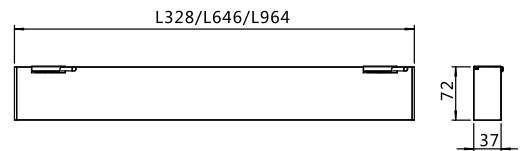
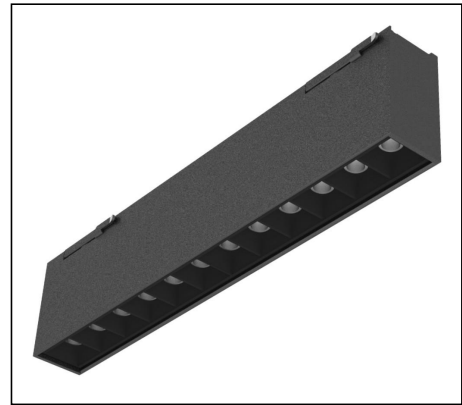

Ordering Information:

Length	Power	CRI	Beam Angle	Luminous	CCT	Housing	Part Number	
							○ White	● Black
328mm	15W	>80	15°/24°/36°/15x35°	1200 lm	2700K	○	SD1-L328A-15W-827-W-**	
						●	SD1-L328A-15W-827-B-**	
				1300 lm	3000K	○	SD1-L328A-15W-830-W-**	
						●	SD1-L328A-15W-830-B-**	
				1400 lm	4000K	○	SD1-L328A-15W-840-W-**	
						●	SD1-L328A-15W-840-B-**	
646mm	30W	>80	15°/24°/36°/15x35°	2300 lm	2700K	○	SD1-L646A-30W-827-W-**	
						●	SD1-L646A-30W-827-B-**	
				2400 lm	3000K	○	SD1-L646A-30W-830-W-**	
						●	SD1-L646A-30W-830-B-**	
				2450 lm	4000K	○	SD1-L646A-30W-840-W-**	
						●	SD1-L646A-30W-840-B-**	
964mm	40W	>80	15°/24°/36°/15x35°	3100 lm	2700K	○	SD1-L964A-40W-827-W-**	
						●	SD1-L964A-40W-827-B-**	
				3150 lm	3000K	○	SD1-L964A-40W-830-W-**	
						●	SD1-L964A-40W-830-B-**	
				3200 lm	4000K	○	SD1-L964A-40W-840-W-**	
						●	SD1-L964A-40W-840-B-**	

***: Angle 15/24/36/15x35



Technical Data test pattern

L328A

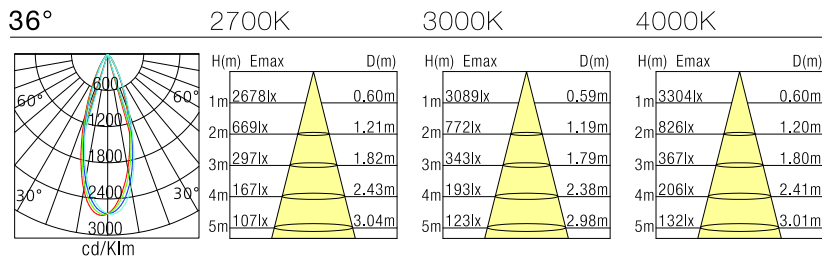
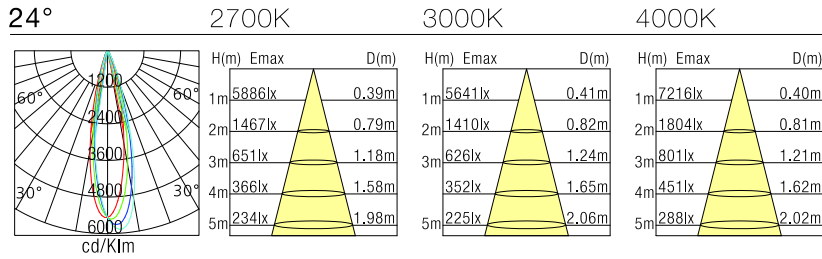
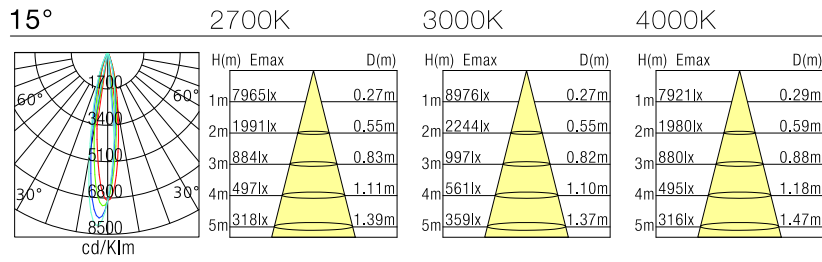

L646A

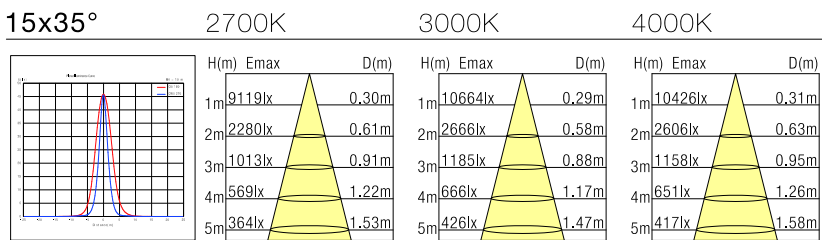
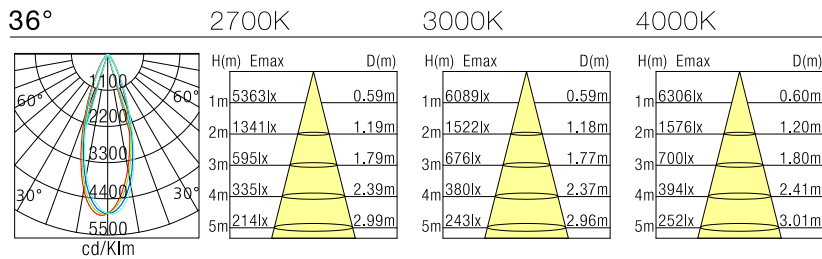
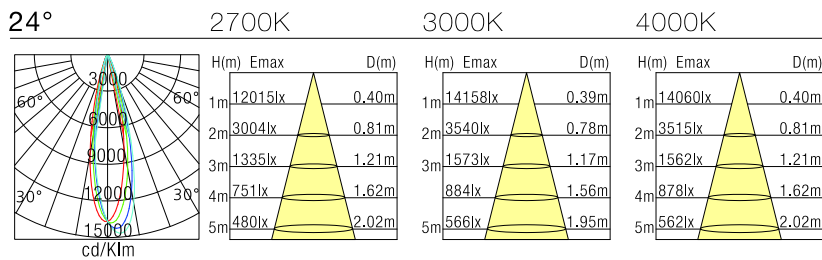

Installation instruction

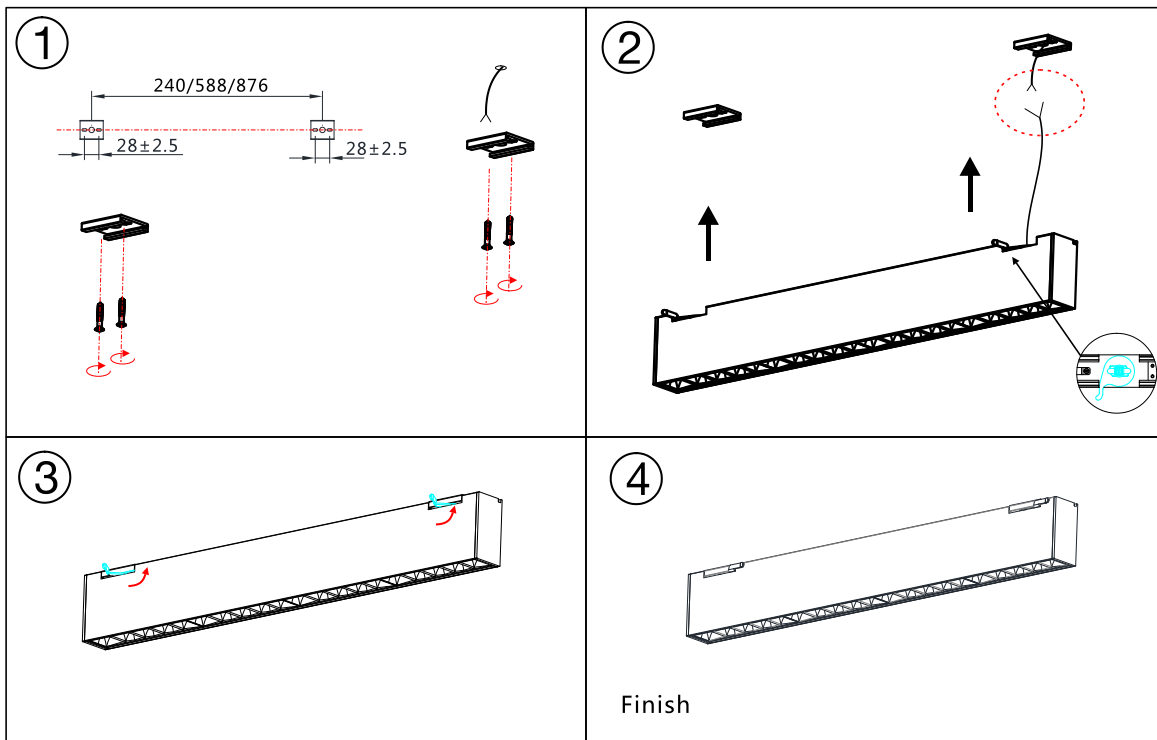

Packaging:

L328A

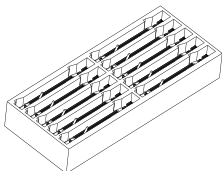

Inner Box

L690*W285*H110mm

10pc/box

GW: 8kg/box

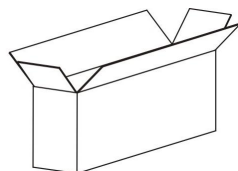

Master Carton

L700*295*265mm

20pc/box

GW: 17.2kg/box

L646A

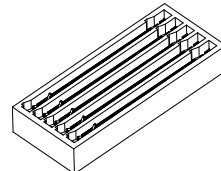

Inner Box

L690*W285*H110mm

5pc/box

GW: 7kg/box

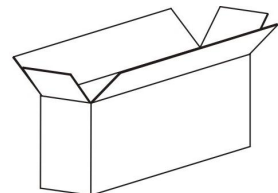

Master Carton

L700*295*265mm

10pc/box

GW: 15.2kg/box

L964A

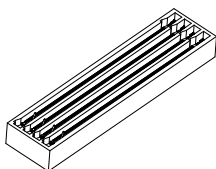

Inner Box

L995*W223*H110mm

4pc/box

GW: 8kg/box

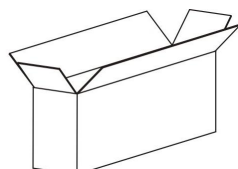

Master Carton

L1000*240*265mm

8pc/box

GW: 17.2kg/box

